

KH – KL multiple

KH2, KH2R, KH4, KH4R, KH6, KH6R
KL2, KL2R, KL4, KL4R, KL6, KL6R

UNIT FOR VENTILATION WITH SEVERAL 230V~ (AC) AND 24V= (DC) MOTORS

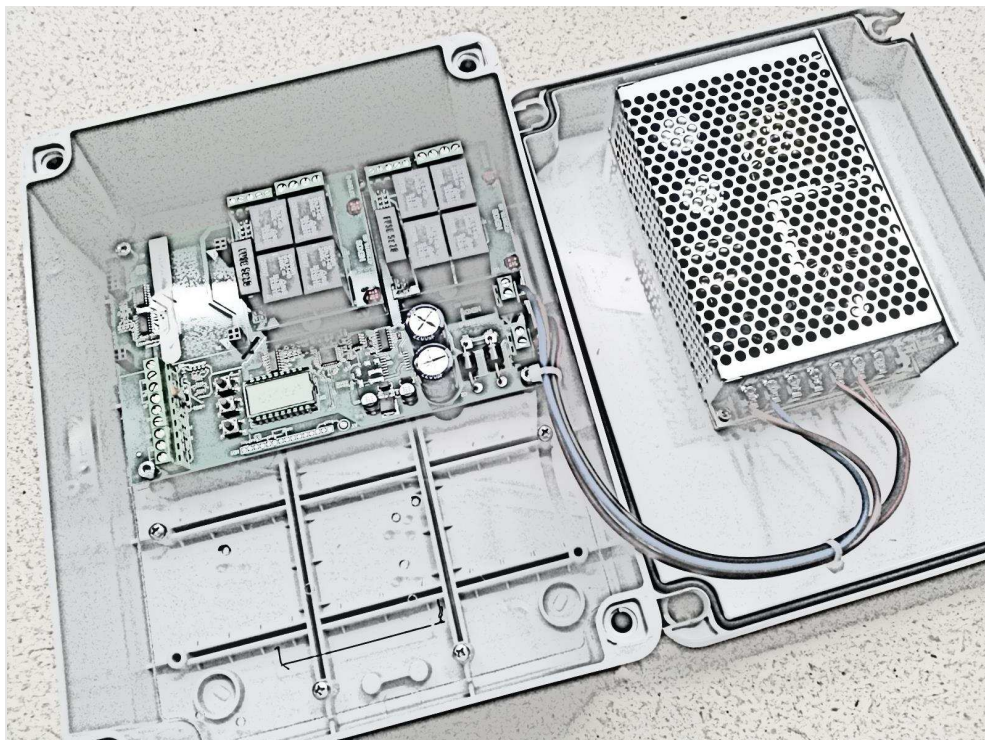

MANUAL FOR INSTALLATION AND USE



English



The machine described in this manual has been manufactured in accordance with safety standards and conforms to the stipulations of current standards in force. When correctly assembled, installed and used according to the present instructions, it will not generate any danger for persons, animals or items.

Products subject to EU directives comply with the essential requirements stipulated by the latter. **CE** markings mean that our products can be sold and installed throughout the European Union without any further formality.

The **CE** marking on the product, packaging and indications for use provided with the product indicate 'presumed conformity to the directives' issued by the European Community.

The manufacturer holds the technical archive with documentation providing that products have been examined and evaluated for conformity to directives.

Symbols used in the manual



DANGER

This indication draw the attention about potential dangers for safety and health of peoples and animals.



INFORMATION

This information give further suggestions.



ATTENTION

This indication draw the attention about potential dangers for the product itself.



WARNING

This indication draw the attention about potential damages to goods.



ENVIRONMENTAL INSTRUCTION

Environmental indication draw the attention about potential dangers for the environment.

Contents

1.	SAFETY INDICATIONS	4
1.1.	General notes	4
1.2.	Notes for functioning and use	4
2.	CONSTRUCTION AND REGULATORY REFERENCES	5
3.	TECHNICAL DATA	5
4.	ID PLATE AND MARKING DATA	6
5.	RECOMMENDATIONS AND INSTRUCTIONS FOR ASSEMBLY	6
6.	TECHNICAL OPERATING INFORMATION	7
6.1.	General instructions	7
6.2.	Programming	8
6.2.1.	Programming Display and Programming Menu	8
6.2.2.	Errors table	12
6.3.	Settable functions	12
6.3.1.	General Open-Close (on main board) - In01, In02	12
6.3.2.	Rain sensor - Parameters P005, P104, P204, P304, P404, P504, P604	13
6.3.3.	Wind sensor - Parameters P103, P203, P303, P403, P503, P603	13
6.3.4.	Cron / Timer input (on main board) - Parameters P105, P205, P305, P405, P505, P605	13
6.3.5.	Sensor priority – Parameter P006	14
6.3.6.	Motor reset time – Parameters P102, P202, P302, P402, P502, P602	14
6.3.7.	Other parameters – Parameters P101, P201, P301, P401, P501, P601, Add, dEL, Rese	14
6.4.	Saving a PIK radio remote control	14
6.5.	Saving a radio remote control without access to the board	15
7.	OVERALL DIMENSIONS	16
8.	CONNECTION DIAGRAM OF THE STATION	17
9.	CONNECTION OF THE EXPANSION MODULES TO THE MAIN BOARD	18
10.	ENVIRONMENTAL PROTECTION	19
11.	CERTIFICATE OF GUARANTEE	19
12.	DECLARATION OF CONFORMITY	20

1. SAFETY INDICATIONS

1.1. General notes



ATTENTION: Before installing this appliance, ensure all safety indications have been read carefully and understood in order to prevent contact with electricity, injury or any other incident. The manual should be conserved for further consultation at a later date.



The manufacturer accepts no responsibility for damage to people, animals or things incurred by improper use.



Use for any applications other than those indicated must be authorised by the manufacturer after technical review of the assembly.



Plastic bags, polystyrene, small metal parts such as nails, staples etc. should be placed out of the reach of children as they constitute a potential source of risk.



Do not use solvents or jets of water to wash the appliance. The appliance should not be submerged in water.

1.2. Notes for functioning and use



This device is intended only and exclusively for the use for which it was designed, and the manufacturer cannot be held liable for damage due to improper use.

KH./R and **KL./R** have been designed and constructed exclusively to execute maneuvers for closing and/or opening windows, roll-up blinds, curtains and sunshades, assisted by the aid of sensors for rain, wind, brightness and temperature.

Specific use is reserved for automatic ventilation and air-conditioning of rooms, which is carried out through the connected motors; **any use for applications other than those specified must be authorized by the manufacturer, upon technical verification.**



The appliance must be installed by competent and qualified technical personnel. Improper installation and use make the unit dangerous for people and things.



To ensure efficient separation from the grid, an approved type of bipolar pulse switch should be used. An omnipolar general power switch with minimum distance of 3 mm between contacts should be installed upstream of the control line.





Before carrying out any cleaning or maintenance, make sure the equipment has been disconnected from the electricity supply. To guarantee safe working conditions, we recommend all cables are disconnected.



Attention: in the event of breakage or malfunction, switch the appliance off at the general switch and call for the services of a qualified technician.

 Repairs should only be performed by qualified personnel at assistance centres authorised by the manufacturer.

 In the event of any problems or queries, consult your agent or contact the manufacturer directly.

 Always request exclusive use of original spare parts. Failure to respect this condition could compromise safety and invalidate the benefits contained in the warranty for the appliance.

 The product must be disposed of in compliance with local environmental regulations and not as household waste.

2. CONSTRUCTION AND REGULATORY REFERENCES

 This product was designed to be used with products suitably studied for the specific application. If assembled incorrectly, use of the product with other devices may result in damage or malfunctions.

 The power supply system and electrical connection must comply with EU standards for electrical systems.

 **The equipment has double electrical insulation and thus does not require an earth wire. All devices connected to the station must be earthed by the installer unless equipped with double insulation.**

 The stations are constructed according to European Union directives and certified in conformity with the **CE** mark. All the devices connected to the control units must be manufactured according to current regulations and in compliance with EC standards.

3. TECHNICAL DATA

Model	KH2 - KH2R KH4 - KH4R KH6 - KH6R	KL2 KL2R	KL4 KL4R	KL6 KL6R
Power supply voltage of the station	230 V~ (±10%) 50 Hz			
Output voltage	230 V~ (±10%) 50 Hz	24V = dc		
Maximum switchable output current per motor	1 A (2.5 A Fuse per module)			
Maximum power absorbed by the station	15W (station only)	75W	100W	150W
Service type	S1			
Double electrical insulation	NO			
Setup for connection to external devices	Wind sensor - Rain sensor - Daily timer - General open-close command			
Operating temperature	-5 ÷ +60 °C			
Degree of protection	IP43			

The data provided in these illustrations is non-binding and subject to change, even without advance notice.

4. ID PLATE AND MARKING DATA

KH../R and KL../R have **CE** marking and are destined for use in the European Union without further requirements. The **CE** marking on the product, packaging and indications for use provided with the product indicate 'presumed conformity to the directives' issued by the European Community.

The manufacturer holds the technical archive with documentation providing that products have been examined and evaluated for conformity to directives.

ID plate data are indicated on a polyethylene adhesive label applied externally on the outside of the container, printed in black on a grey background. Values conform to EC requirements in force. See figure for example of labelling.

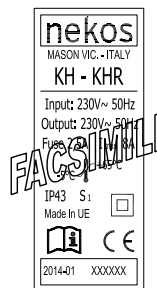



5. RECOMMENDATIONS AND INSTRUCTIONS FOR ASSEMBLY

**THESE INSTRUCTIONS ARE INTENDED FOR TECHNICAL AND SPECIALIZED PERSONNEL.
THUS BASIC SAFETY AND WORKING TECHNIQUES ARE NOT DISCUSSED.**

In order to guarantee perfect operation of the system and facilitate installation, follow the instructions and warnings below.

 Perform a thorough visual inspection of the device to ensure it wasn't damaged during transport.

 To avoid the hazard of injury or death caused by the electrical current, always disconnect the voltage from the power supply line before carrying out any wiring or adjustment operation.

 The electrical power supply system must be designed and implemented in compliance with current standards.

 Caution. Check that the electric power supply used corresponds to that specified on the "technical data" label attached to the station.

The KL../1 and KH../R series meteorological control units, in order to operate to their full potential, must be assisted by a wind speed detector and/or rain sensor and/or brightness sensor and/or temperature sensor.

The rain and wind detectors are placed outside in direct contact with the weather, on the roof or in a similar position if possible.

The rain sensor should be placed in a slightly inclined position in order to facilitate water run-off and in a position which is not protected from falling rain; positioning the sensor underneath trees is not recommended as this will alter the natural meteorological event.

The wind sensor should be placed far from obstacles that deform or protect against the wind flow; thus avoid placing the sensor near gutters, trees, walls, etc.

When assembling the KL../R and KH../R stations, in order to guarantee perfect operation of the system and facilitate installation, follow the instructions and warnings below.

Some recommendations for installation.

- a) Select the most suitable location for the control unit based on the shape and structure of the building. The station does not require any maintenance, thus it can be placed in an out-of-the-way position, protected against direct weather exposure.

- b) Position the box of the device in the selected position and use a pencil to mark the drilling hole on the support (*wall or other*).
- c) Drill the hole using a drill bit with diameter corresponding to the selected plug or fastening screw.
- d) Mount the equipment box and fix the screws definitively.
- e) Drill the box to allow passage of the connection cables in the desired position using a Ø10 drill bit. Remove the electronic board from the box to avoid damaging it permanently when drilling.
- f) Complete the path of the electrical connection cables. Pass the cables through the holes and make the electrical connections according to the wiring diagram provided on the following pages.
- g) Perform the final test checking the intervention of the automatic devices. To make the rain sensor intervene, just touch the sensitive part with a finger. There is no danger of shock since this device is low-voltage. To make the wind sensor intervene, turn the fan for at least 5 seconds.

6. TECHNICAL OPERATING INFORMATION

6.1. General instructions

The control unit is composed of a “main board” which is set up for insertion of “expansion module boards”.

The “expansion module” boards differ depending on the control voltage of the motors. The modules can be for 24V= (dc) motors or 120/230V ~ 50/60Hz (ac) motors.

The control unit is set up for insertion of a maximum of 3 “expansion modules”.

Each expansion module can control 2 motors of the same type.



Caution: depending on the control unit selected, a power supply unit with suitable power and Ampere range is included.

Model	Number of expansion modules (Control voltage)	Number of motors provided for
KH2 – KH2R	1 – (230V ~ 50/60Hz)(ac)	2
KH4 – KH4R	2 – (230V ~ 50/60Hz)(ac)	4
KH6 – KH6R	3 – (230V ~ 50/60Hz)(ac)	6
KL2 – KL2R	1 – (24V= dc)	2
KL4 – KL4R	2 – (24V= dc)	4
KL6 – KL6R	3 – (24V= dc)	6



Caution: if 24V= (dc) optional modules are inserted, check the sizing of the power supply unit to ensure it has a suitable Ampere range.

Each expansion module is provided with inputs for manual commands of each individual motor. For control of the connected motors, the installation of a provisional manual button, also known as a “*deadman's switch*” is recommended. The **KL..R** and **KH..R** models provide for use of both the **PIK** radio remote control, with 433.92 MHz proprietary protocol, and manual control.

6.2. Programming

6.2.1. Programming Display and Programming Menu



Ensure that you have fully understood the meaning of the terms used in the following information and instructions.

A display is installed on the electronic board of the station which displays the programming menu for all the station functions and provides automatic operating instructions and management instructions for the connected weather sensors.

All the settings of the **PXXX** functional parameters must be made through the keys and display of the station, changing the preset values **F** [factory-set].

→ The **OK** key is used to enter the programming menu and confirm the setting of each individual parameter.

→ The **+** (*plus*) key is used to scroll up through the programming menu or increase the value of the parameter within the menu.

→ The **-** (*minus*) key is used to scroll down through the programming menu or decrease the value of the parameter within the menu.

→ The **+** (*plus*) and **-** (*minus*) keys pressed together are used to exit the programming menu.



IMPORTANT: to memorize the set parameters, press the + (*plus*) and - (*minus*) until the complete exit from the programming menu (display off).

(display)



The initial menu is free of any writing when no input is active; otherwise it shows the activated function with the following messages:

- **In01** - general Open
- **In02** - general Close
- **In11** - motor 1 Open
- **In12** - motor 1 Close
- **In21** - motor 2 Open
- **In22** - motor 2 Close
- **In31** - motor 3 Open
- **In32** - motor 3 Close
- **In41** - motor 4 Open
- **In42** - motor 4 Close
- **In51** - motor 5 Open
- **In52** - motor 5 Close
- **In61** - motor 6 Open
- **In62** - motor 6 Close
- **pk01** - channel 01 of the PIK radio remote control
- **u Km** - wind speed
- **r** - rain state
- **cron** - timed thermostat / timer

Pressing **+** (*plus*) and **-** (*minus*) together displays the total number of channels of the PIK radio remote control saved in the memory.

-↑ +↓	P001	Wind sensor activation threshold (5 - 50) Km/h F[30]
-↑ +↓	P005	Rain sensor exclusion time (0 - 10) min F[0]
-↑ +↓	P006	Sensor priority (1 - 3) F[1]. Priority can be selected for only one sensor, where: <ul style="list-style-type: none"> • 1=rain • 2=wind, 3=timer
-↑ +↓	P101	Motor 1 work time (10 - 120) s F[60]
-↑ +↓	P102	Motor 1 reset time (0 - 240) s F[0]
-↑ +↓	P103	Motor 1 Wind sensor function (0 - 2) F[0]. Set the action when active as follows: <ul style="list-style-type: none"> • 0=none • 1=open • 2=close
-↑ +↓	P104	Motor 1 Rain sensor function (1 - 2) F[2]. Set the action when the input is active, as follows: <ul style="list-style-type: none"> • 1=open • 2=close
-↑ +↓	P105	Motor 1 Timer function F[0]. Set the action when active as follows: <ul style="list-style-type: none"> • 0=none • 1=open • 2=close
-↑ +↓	P201	Motor 2 Work time (10 - 120) s F[60]
-↑ +↓	P202	Motor 2 Reset time (0 - 240) s F[0]
-↑ +↓	P203	Motor 2 Wind sensor function (0 - 2) F[0]. Set the action when active as follows: <ul style="list-style-type: none"> • 0=none • 1=open • 2=close

-↑ +↓	P204	Motor 2 Rain sensor function (1 - 2) F[2]. Set the action when the input is active, as follows: <ul style="list-style-type: none"> • 1=open • 2=close
-↑ +↓	P205	Motor 2 Timer function F[0]. Set the action when active as follows: <ul style="list-style-type: none"> • 0=none • 1=open • 2=close
-↑ +↓	P301	Motor 3 Work time (10 - 120) s F[60]
-↑ +↓	P302	Motor 3 Reset time (0 - 240) s F[0]
-↑ +↓	P303	Motor 3 Wind sensor function (0 - 2) F[0]. Set the action when active as follows: <ul style="list-style-type: none"> • 0=none • 1=open • 2=close
-↑ +↓	P304	Motor 3 Rain sensor function (1 - 2) F[2]. Set the action when the input is active, as follows: <ul style="list-style-type: none"> • 1=open • 2=close
-↑ +↓	P305	Motor 3 Timer function F[0]. Set the action when active as follows: <ul style="list-style-type: none"> • 0=none • 1=open • 2=close
-↑ +↓	P401	Motor 4 Work time (10 - 120) s F[60]
-↑ +↓	P402	Motor 4 Reset time (0 - 240) s F[0]
-↑ +↓	P403	Motor 4 Wind sensor function (0 - 2) F[0]. Set the action when active as follows: <ul style="list-style-type: none"> • 0=none • 1=open • 2=close
-↑ +↓		

P404	Motor 4 Rain sensor function (1 - 2) F[2]. Set the action when the input is active, as follows: <ul style="list-style-type: none"> • 1=open • 2=close
------	---

-↑ +↓

P405	Motor 4 Timer function F[0]. Set the action when active as follows: <ul style="list-style-type: none"> • 0=none • 1=open • 2=close
------	---

-↑ +↓

P501	Motor 5 Work time (10 - 120) s F[60]
------	--------------------------------------

-↑ +↓

P502	Motor 5 Reset time (0 - 240) s F[0]
------	-------------------------------------

-↑ +↓

P503	Motor 5 Wind sensor function (0 - 2) F[0]. Set the action when active as follows: <ul style="list-style-type: none"> • 0=none • 1=open • 2=close
------	---

-↑ +↓

P504	Motor 5 Rain sensor function (1 - 2) F[2]. Set the action when the input is active, as follows: <ul style="list-style-type: none"> • 1=open • 2=close
------	---

-↑ +↓

P505	Motor 5 Timer function F[0]. Set the action when active as follows: <ul style="list-style-type: none"> • 0=none • 1=open • 2=close
------	---

-↑ +↓

P601	Motor 6 Work time (10 - 120) s F[60]
------	--------------------------------------

-↑ +↓

P602	Motor 6 Reset time (0 - 240) s F[0]
------	-------------------------------------

-↑ +↓

P603	Motor 6 Wind sensor function (0 - 2) F[0]. Set the action when active as follows: <ul style="list-style-type: none"> • 0=none • 1=open • 2=close
------	---

-↑ +↓

P604	Motor 6 Rain sensor function (1 - 2) F[2]. Set the action when the input is active, as follows: <ul style="list-style-type: none"> • 1=open • 2=close
------	---

-↑ +↓

P605	Motor 6 Timer function F[0]. Set the action when active as follows: <ul style="list-style-type: none"> • 0=none • 1=open • 2=close
------	---

-↑ +↓

Add	Adds PIK radio remote control channel in the memory
-----	---

-↑ +↓

chc	Changes the association: PIK radio remote control channel No. → Motor No.
-----	---

-↑ +↓

dEL	Deletes PIK radio remote control channel from the memory
-----	--

-↑ +↓

rESE	Restores the Default values (press twice and the message "end" appears).
------	--

6.2.2. Errors table

(display) 	The following messages appear on the display in case of error: <ul style="list-style-type: none"> - FULL – radio remote control memory full - Err - the radio remote control is not recognized in either delete or write
---	--

6.3. Settable functions

6.3.1. General Open-Close (on main board) - In01, In02



For simplicity, from now on the **opening** of the window is associated with forward movement of the motor and **closing** of the window is associated with backward movement of the motor.

Two "General Command" control inputs "in01" and "in02" of the voltage-free **n.o.** / **n.c.** type are provided on the terminal block.

Activation of the general open or general close command affects all the motor outputs of the associated modules: motor 1-motor 2 of the first module, motor 3-motor 4 of the second module and motor 5-motor 6 of the third module.

When the inputs are activated, the respective message appears on the display: "in01" and "in02".

The button operation is the following:

- **Open/Close function in self-hold mode (n.o.).** Upon closure of the contact - *and immediate release* - the station instructs the forward/backward operation of the motors for the motor work time set in P101,P201,P301,P401,P501,P601.
If you would like to stop the movement of the motor, just give another pulse to the command of that particular operation direction. Vice versa, if you give a pulse in the opposite direction of movement, the motor changes operation direction.
- **Deadman Open/Close function (n.o.).**
Upon closure of the contact - *and retention for more than 2 seconds* - the station instructs the forward/backward operation of the motor until the contact itself is released.

6.3.2. Rain sensor - Parameters P005, P104, P204, P304, P404, P504, P604

Upon activation of the rain sensor, the respective message “r” appears on the display,

- The RAIN input is set up to be connected to a device that detects rain and provides a voltage-free n.o. contact. The opening/closing action of the window can be set using the P104-P204-P304-P404-P504-P604 menu.

- Supply voltage 12V for rain sensor	
Tension (V)	Maximum Current (mA)
12V DC	100mA

Please contact Nekos technical office to use rain sensors other than NSR1

- In case of rain with the window closed, the window can be reopened by excluding intervention of the rain sensor for the time set in parameter P005.



Caution. If you do not want to use this function, leave the parameter P005 = 0

6.3.3. Wind sensor - Parameters P103, P203, P303, P403, P503, P603

Upon activation of the wind sensor, the respective message appears on the display: “u XX”, where XX is the value of the detected wind speed expressed in Km/h.

The intervention threshold of the wind sensor is set by parameter P001 within the range **5 Km/h - 50 Km/h.**

The opening or closing of the windows can be set by the parameter P103-P203-P303-P403-P503-P603. Temporary wind gusts do not activate the function.

6.3.4. Cron / Timer input (on main board) - Parameters P105, P205, P305, P405, P505, P605

A “timer” command input of the voltage-free **n.o. / n.c.** type is provided on the terminal block. The command comes from any device that has a voltage-free contact output, such as a timed thermostat, timer, clock, etc.

Activation of the timer command affects all the motor outputs of the associated modules: motor 1-motor 2 of the first module, motor 3-motor 4 of the second module and motor 5-motor 6 of the third module.

The opening or closing of the windows can be set by the parameter P105-P205-P305-P405-P505-P605.

6.3.5. Sensor priority – Parameter P006

By means of parameter P006, higher priority can be assigned to one of the sensors in case events occur simultaneously.

6.3.6. Motor reset time – Parameters P102, P202, P302, P402, P502, P602

After intervention of the sensors (rain, wind) and the reset time set by parameter P102 – P202 – P302 – P402 – P502 – P602 has passed, the window returns to the previous scenario.



Caution.

If you do not want to use this function, leave the parameter P102 – P202 – P302 – P402 – P502 – P602 = 0

With P102 – P202 – P302 – P402 – P502 – P602 = 0, when a sensor intervenes the window goes to the position instructed by the sensor and remains there.

6.3.7. Other parameters – Parameters P101, P201, P301, P401, P501, P601, Add, dEL, rESE

- The parameter P101 – P201 – P301 – P401 – P501 – P601 is used to set the work time of the motor on the window.
- The parameter “**Add**” of the menu is used to save one or more channels of the PIK radio remote control in the station.
- The parameter “**dEL**” of the menu is used to delete one or more channels of the PIK radio remote control saved previously.
- The parameter “**rESE**” of the menu is used to restore the factory-set values (Default).

6.3.8. Saving a PIK radio remote control



This paragraph concerns only the KL_R or KH_R station equipped with PIK radio remote control.

The remote electronic control or, more simply, radio remote control, is the standard-supplied device for controlling the KL_R or KH_R station.



For more details on the characteristics and operation of the **PIK** radio remote control, consult the instructions manual provided with the radio remote control itself; not all the functions of the radio remote control are listed in this manual.



THE TRANSMITTER IS NOT FACTORY-PROGRAMMED.

First follow the radio remote control instructions and then those provided below concerning the specific operation of the station.

The KL_R or KH_R station can accept up to 6 PIK radio remote controls. The same functions only with the PIK radio remote control with NEKOS proprietary code (rolling code).

Save procedure:

- Equip yourself with the radio remote control, checking beforehand that it is working, has charged batteries and is in good condition.
- Select the "Add" item in the menu.
- Press the "OK" button of the control unit.
- The message "Push" will appear on the display.
- On the PIK radio remote control (see the instructions provided with the radio remote control), select any channel between CH1 and CH6 and press any one of the ▲/▼ ARROW or STOP buttons on the PIK for about 1 second.
- The "OK" message will appear on the display indicating that the save process was successful.
- The radio remote control is now saved and the motors are controlled by the respective channels. (CH1=motor 1; CH2=motor 2..... CH6=motor 6)

End

Repeat the procedure for any other radio remote controls.

Advanced procedure: associate desired channels or free a channel ("chc" menu).

- Select the "CHC" item in the menu of the station.
- Press the "OK" button of the control unit.
- The message "Push" will appear on the display.
- Select the desired channel on the PIK radio remote control and press any one of the ▲/▼ ARROW or STOP buttons for about 1 second.
- The list of motors from MOT1 to MOT6 and NULL will appear on the display. If you want to "free" a certain channel of the PIK (e.g., make it usable for other applications), select "NULL".
- Use the +/- buttons of the control unit to scroll through the motors and select the motor you want to associate with the selected channel.
- Press OK.
- The association is complete.

Repeat the procedure for any other radio remote controls or channels.

6.4. Saving a radio remote control without access to the board

Saving a new radio remote control remotely, i.e. without access to the electronic board of the station, can occur only if the user already has a previously saved radio remote control.



Obtain the instructions manual of the PIK radio remote control for consultation.

The programming is achieved by carrying out the following procedure:

- Equip yourself with the PIK radio remote control to be saved and set it on any channel (see the instructions of the radio remote control).
- Equip yourself with the already saved and operational radio remote control, press the following buttons in sequence: **F1**, **F2** and then **STOP**.
- Within 5 seconds on the radio remote control to be saved, press one of the ▲ arrow, **STOP** or ▼ arrow buttons twice.
- Now the second radio remote control is operational.

7. OVERALL DIMENSIONS

The container box is made of impact-resistant ABS engineering plastic, RAL7035 grey colored, having a cover with gasket and IP43 degree of protection.

The feed-through holes for the cables, both those for the electric power supply and those coming from the sensors, as well as those going to the motors to be controlled, are not present on the box. The holes must be made by the installer as needed.



During the drilling of the holes, be very careful so as not to damage the electronic board.

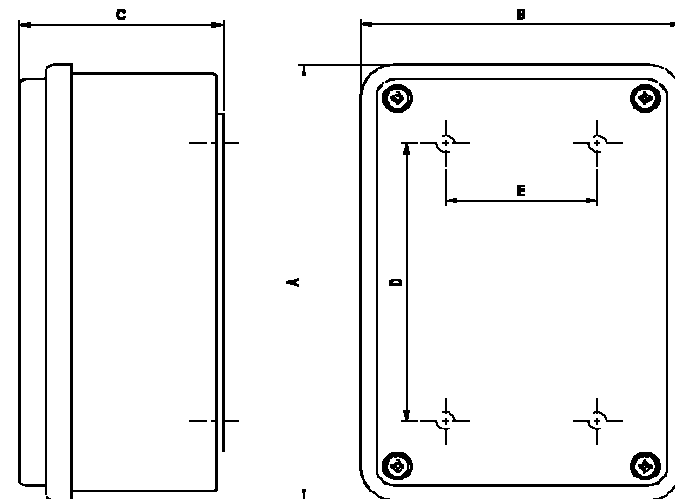

Dimension				
A	B	C	D	E
240	190	120	220	152

8. CONNECTION DIAGRAM OF THE STATION

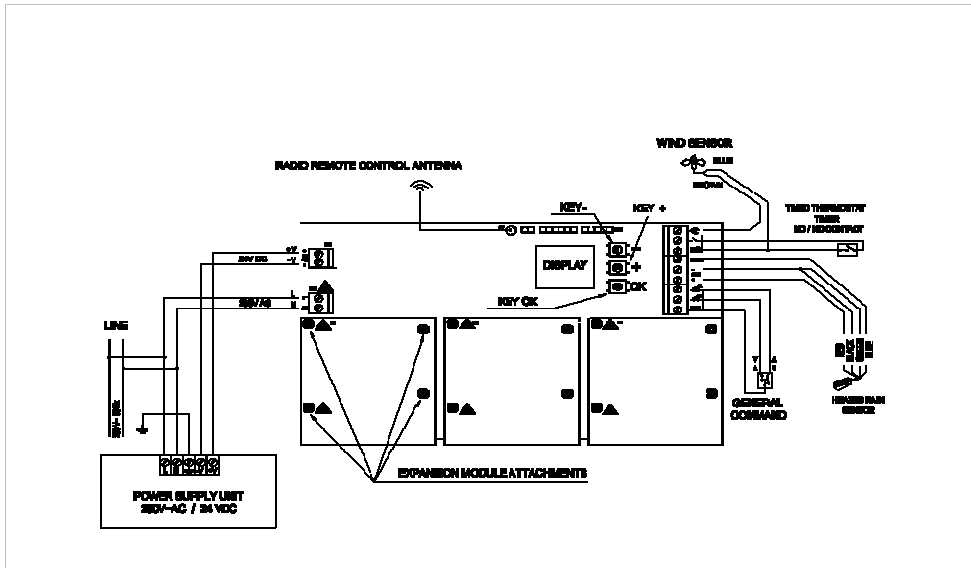
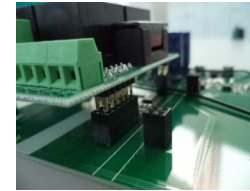
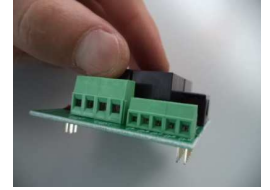

Fig. 7.1 Main Board

9. CONNECTION OF THE EXPANSION MODULES TO THE MAIN BOARD

Two types of expansion modules are available, modules for 24V= (dc) motors and modules for 230V~ (ac) motors.

Each module controls two motors separately.



If 24V= (dc) modules are used, it is important that you check the power supply unit included in the supply; each 24V= (dc) module requires an additional power of about 50W from the power supply unit.

Example:

I purchase a KL4 station that includes two 24V= (dc) modules, and I want to add an additional 24V= (dc) module. So I have to switch the 100W power supply unit of the KL4 station with a 150W power supply unit.

The same KL4 station, with the addition of a 230V~ (ac) module, does not require any modifications of the power supply unit.

The 230V~ (ac) are powered directly from the mains network; in this case it's not necessary to check the available power of the power supply unit.

The 24V= (dc) modules and the 230V~ (ac) modules can be positioned in the appropriate seats provided on the main board, regardless of the type of module.

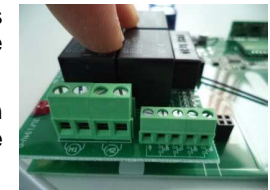

It is advisable to check that each module contains a fuse for protection of the associated pair of motors.

For insertion of the modules in the seats provided, just insert the pin connectors in the appropriate seats, ensuring that the terminals face the exterior of the main board edge, see image to the side.



Caution.

The outputs of the modules of the 230V~ (ac) motors are inverted with respect to the modules of the 24V= (dc) motors.

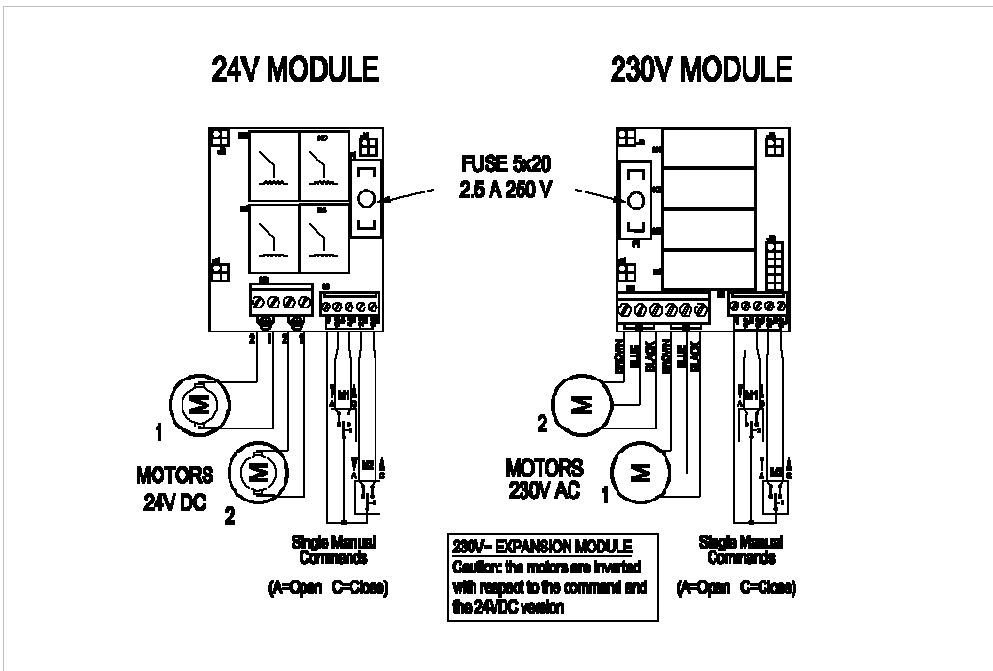

Fig. 7.2 Expansion Modules

10. ENVIRONMENTAL PROTECTION



All materials used in the manufacture of this appliance are recyclable.

We recommend that the device itself, and any accessories, packaging, etc. be sent to a centre for ecological recycling as established from laws in force on recycling. The device is mainly made from the following materials: aluminium, zinc, iron, plastic of various type, cuprum. Dispose materials in conformity with local regulations about removal.

11. CERTIFICATE OF GUARANTEE

The manufacturer will guarantee good function of the appliance. The manufacturer shall undertake to replace defective parts due to poor quality materials or manufacturing defects in accordance with article 1490 of the Civil Code.

The guarantee covers products and individual parts for **2 years** from the date of purchase. The latter is valid as long as the purchaser possesses proof of purchase and completion of all agreed conditions of payment.

Guarantee of good function of appliances agreed by the manufacturer implies that the latter undertakes to repair or replace free of charge and in the shortest period possible any parts that break while under warranty.

The purchaser is not entitled to any reimbursement for eventual direct or indirect damage or other expenses incurred. Attempt to repair by personnel unauthorised by the manufacture shall render the warranty null and invalid.

The warranty does not cover fragile parts or parts subject to natural wear and tear or corrosion, overload, however temporary etc. The manufacturer will accept no responsibility for eventual damage incurred by erroneous assembly, manoeuvre or insertion, excessive stress or inexpert use.

Repairs performed under guarantee are always "ex factory of the manufacturer". Respective transport expenses (out/back) are the responsibility of the purchaser.



12. CERTIFICATO DI CONFORMITA'

DECLARATION OF CONFORMITY

	NEKOS S.r.l. - Via Capitoni, 7/5 36064 <u>Mason Vicentino</u> (VI) – ITALY ☎ +39 0424 411011 – Fax +39 0424 411013 www.nekos.it info@nekos.it
--	---

Il sottoscritto legale rappresentante del costruttore **NEKOS S.r.l.**
The undersigned, representative of the following manufacturer

dichiara
declares

che il prodotto elettrico:
that the electrical product:

Modello / Model	Designazione / Designation
KH.., KH..R	Centrale alimentazione motori a 230V~ (AC) <i>Control unit for 230V~ (AC) motors</i>
KL.., KL..R	Centrale alimentazione motori a 24V~ (DC) <i>Control unit for 24V~ (DC) motors</i>

è conforme alle disposizioni legislative che traspongono le seguenti direttive:

- Direttiva 2004/108 CE (Direttiva EMC) e successivi emendamenti
- Direttiva 2006/95 CE (Direttiva Bassa Tensione) e successivi emendamenti
Is in accordance with the following Directives:
- *2004/108 EC Directive (EMC Directive) and subsequent amendments*
- *2006/95 EC Directive (Low Voltage Directive) and subsequent amendments*

Ultime due cifre dell'anno in cui è affissa la marcatura CE:
Last two figures of the year of the CE marking:

12

Luogo:
Place: **Mason Vicentino (VI) - Italy**

Data:
Date: **1/08/2014 / 1/08/2014**

Firma:
Signature: **Giuliano Galliazzo**
A.D. - President



NEKOS S.r.l.
I - 36064 - **MASON VICENTINO (VI)** - Via Capitoni, 7/5
Telefono (0039) 0424 411011 Fax (0039) 0424 411013
info@nekos.it - <http://www.nekos.it>