



# CDVI

FR FRANCAIS

EN ENGLISH



## SOLARPW STARPW



**Lecteurs proximité Wiegand 125 Khz**  
***Wiegand 125Khz Proximity Readers***

**Gamme:** Contrôle d'Accès Intégré / **Range:** Integrated Access Control

MANUEL D'INSTALLATION  
INSTALLATION MANUAL

# SOLARPW-STARPW

## Wiegand 125 Khz Proximity Readers

### 1] PRODUCT PRESENTATION

- **Wiegand 26, 30 or 44 bit.**
- **Direct connection.**
- **PCB sealed in epoxy.**
- **Audible and visual feedback.**
- **45cm pigtail wire connection (STARPW).**
- **Versions available:** white, black or grey.

- SOLARPW (L x W x D): 130 x 90 x 28mm.
- STARPW (L x W x D): 130 x 41 x 28mm.
- Technology: 125 Khz.
- Multi card protocol reader - Marin/HD.
- Input voltage: 12V dc.
- Consumption: 100mA.

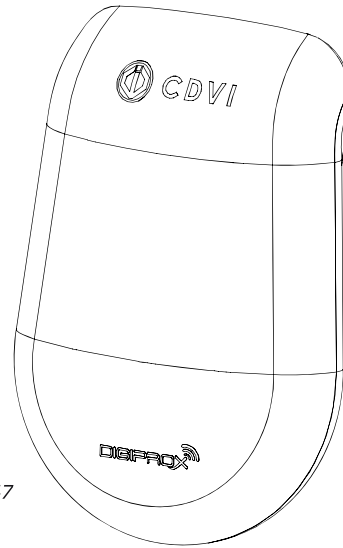
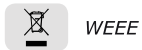
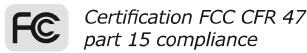
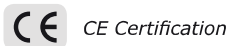

Ref: SOLARPW

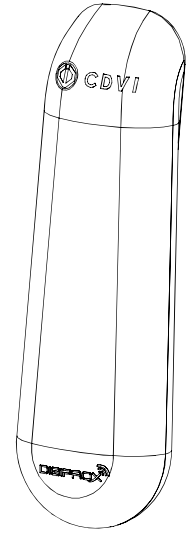

Ref: STARPW

### 2] REMINDERS AND RECOMMENDATIONS

#### Important

To protect the device from back-emf, do not forget to install the varistor across the lock terminals, in parallel.

#### Suggested power supplies

ARD12 & BS60 (in case the reader is powered neither by the controller nor by the reader controller [INTBUSW]).

#### Recommended cables

4 twisted pairs 0.6mm.

#### Environment

When in a humid area or close to the sea, we recommend applying varnish to the terminals to avoid oxidation.

#### This product is supplied with a varistor.



The varistor must be connected directly to the locking system terminals (electric

strikes, electromagnet, or lock) operated by the device. If the device functions with several locking systems, each one must be fitted with a varistor. The varistor limits overload produced by the strike coil, known as self-effect or back-emf. If you are using a "Shear Lock", electromagnet or other type of electric lock, we recommend the use of a dedicated power supply for the lock.

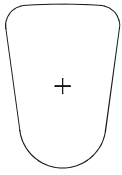

**For optimal illumination, do not fold the cable inside the product.**

### 3] MOUNTING KIT

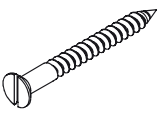
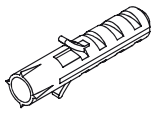
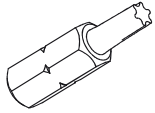
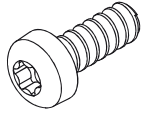
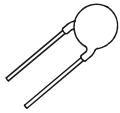
							
	Foam seal	Foam seal	3x30 TF screw	S5 Plastic anchor	TORX bit	3x8 TORX screw	Varistor
SOLARPW	1	-	2	2	1	1	1
STARPW	-	1	2	2	1	1	1

# SOLARPW-STARPW

## Wiegand 125 Khz Proximity Readers

### 4] MOUNTING

Make sure that there are no pieces missing from the mounting kit. Use the correct tools according to the installation (drill, screwdrivers, tape measure,...) and follow the mounting instructions of the reader.

Ref: SOLARPW

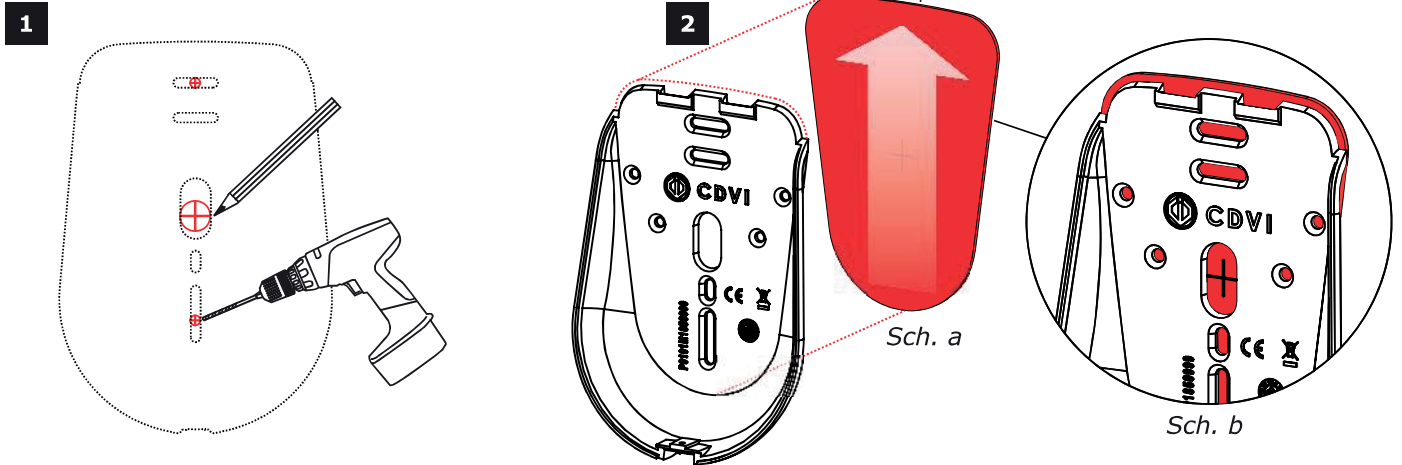

**1** Measure and mark the center lines to determine the reader position. Drill the fixing screw holes (Diameter: 5mm). Drill the wiring access area (Diameter: 15mm).

**2** Place the foam seal at the back of the reader. Take care to begin from the bottom. (Sch. a). The foam seal must be visible (about 2mm) on the top-back of the reader (Sch. b).

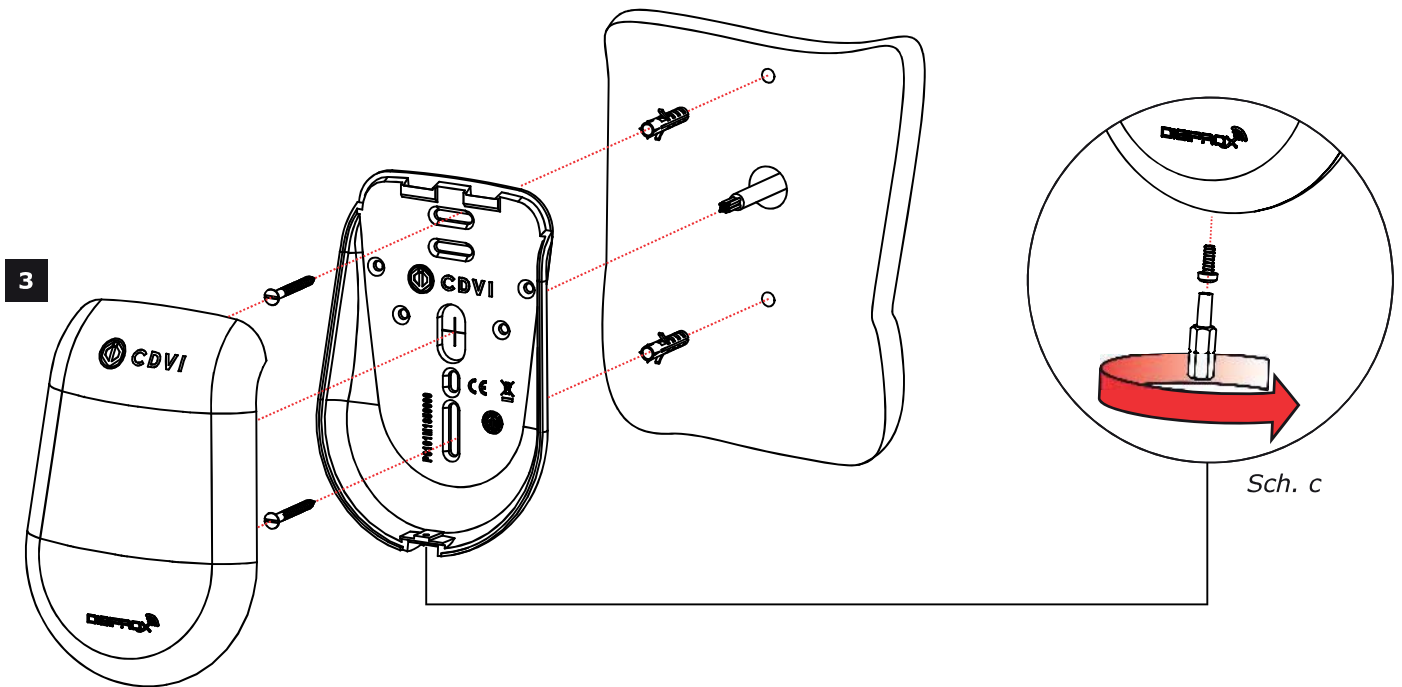

**3** Insert the plastic plugs in the mounting holes, connect the cable (refer to wiring diagram on page 11), then fasten the reader with the TORX® screw using the TORX® bit (Sch. c). Make sure that the varistor is connected across the lock (refer to page 8 "Reminders and recommendations").

**SOLARPW-STARPW**  
Wiegand 125 Khz Proximity Readers

Ref: STARPW

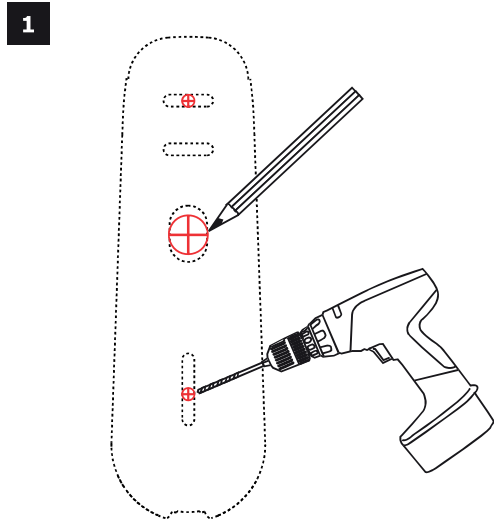

**1** Measure and mark the center lines to determine the reader position. Drill the fixing screw holes (Diameter: 5mm). Drill the wiring access area (Diameter: 15mm).

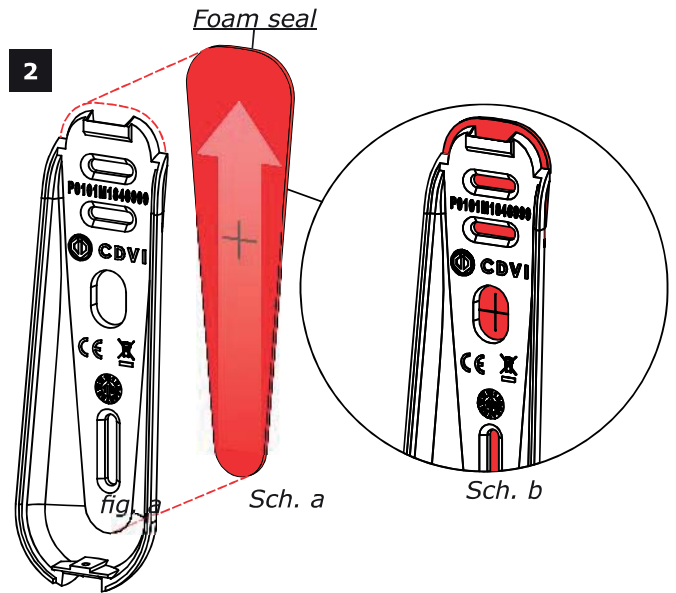

**2** Place the foam seal at the back of the reader. Take care to begin from the bottom. (Sch. a). The foam seal must be visible (about 2mm) on the top-back of the reader (Sch. b).

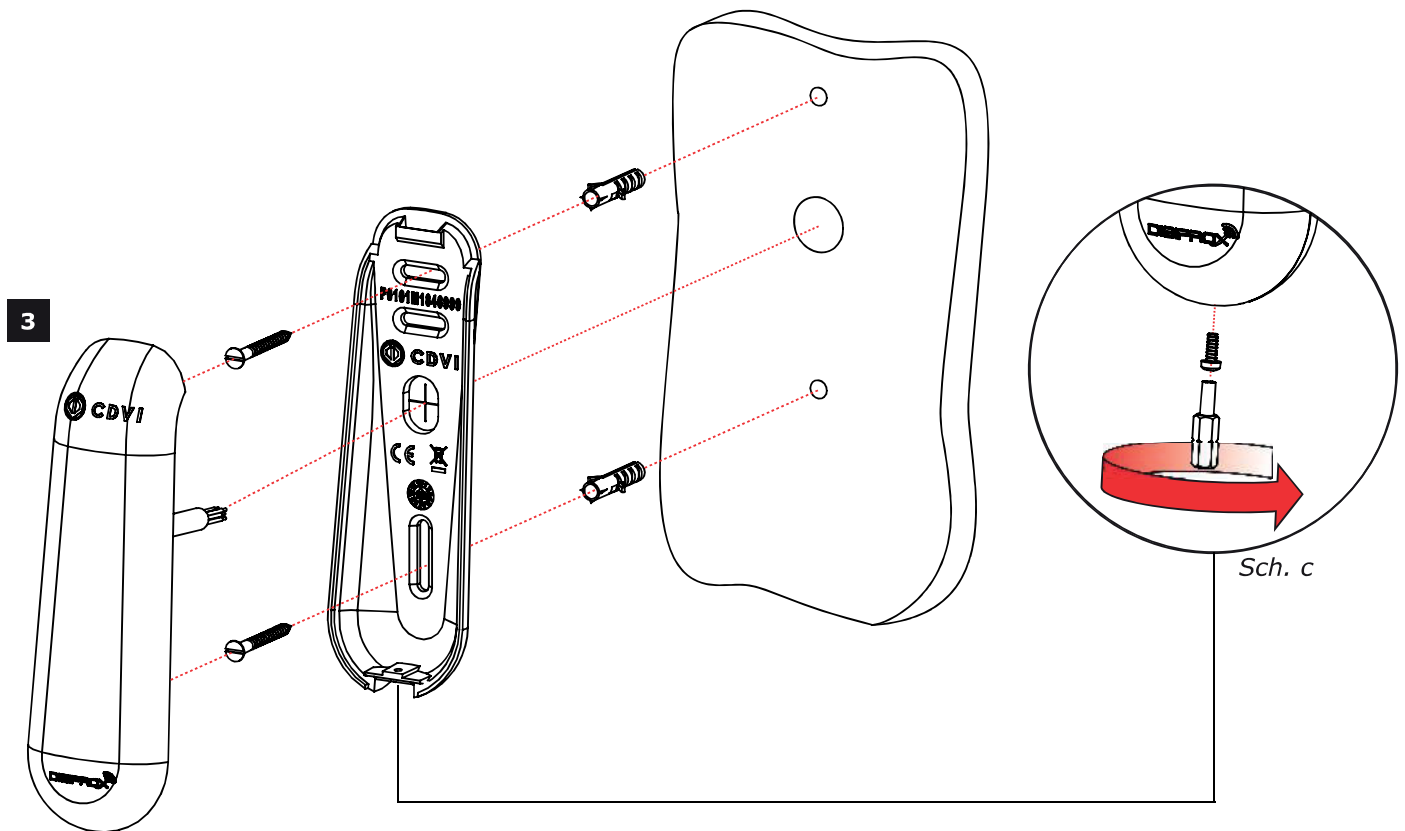

**3** Insert the plastic plugs in the mounting holes, connect the cable (refer to wiring diagram on page 11), then fasten the reader with the TORX® screw using the TORX® bit (Sch. c). Make sure that the varistor is connected on the lock (refer to page 8 "Reminders and recommendations").

# SOLARPW-STARPW

Wiegand 125 Khz Proximity Readers

## 5] WIRING DIAGRAM

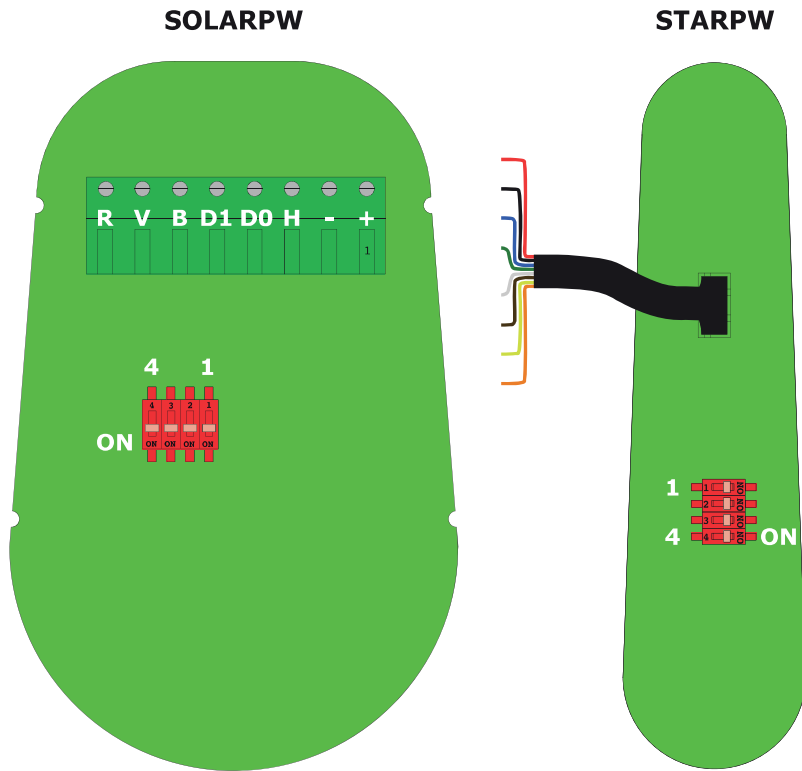

Terminal block (8 points)	
+	Input voltage 12V dc
-	0V
H	Clock
D0	Data 0
D1	Data 1
B	Buzzer
V	Green LED
R	Red LED

Cable	
Red	Input voltage 12V dc
Black	0V
Blue	Clock
Green	Data 0
White	Data 1
Brown	Buzzer
Yellow	Green LED
Orange	Red LED

- When powered up**
- Green LED illuminates for 1 second.
  - RED LED illuminates for 1 second.
  - Buzzer sounds for 1 second.

- Operating mode**
- Buzzer activated with 0V input.
  - LEDs activated with 0V input.

LEDs management		
Green LED	Red LED	Status
OFF	OFF	Off
OFF	ON	red
ON	OFF	green
ON	ON	blue

**Dipswitch 1 & 2 positioning**

4 ON	3 ON	2 ON	1 ON	OFF	1 OFF	2 OFF	26 bit
4 ON	3 ON	2 ON	1 ON	ON	1 ON	2 OFF	30 bit
4 ON	3 ON	2 ON	1 ON	OFF	1 OFF	2 ON	44 bit
4 ON	3 ON	2 ON	1 ON	OFF	1 ON	2 ON	Not used

**Dipswitch 3 positioning**

4 ON	3 ON	2 ON	1 ON	OFF	3 ON	Standard
4 ON	3 ON	2 ON	1 ON	ON	3 ON	Standard

**Dipswitch 4 positioning**

**Pulls up 12 V or 5 V**  
Open collector outputs:

4 ON	3 ON	2 ON	1 ON	OFF	4 OFF	4 ON	5V	12V
4 ON	3 ON	2 ON	1 ON	ON	4 OFF	4 ON	5V	12V

- Card Swiped**
- Badge recognized: the orange LED illuminates and the buzzer activates for 150 milliseconds.



**SOLARPW-STARPW**  
Wiegand 125 Khz Proximity Readers

**6] OUTPUT FORMATS 26, 30 AND 44 BIT WIEGAND**

**Chronograms**

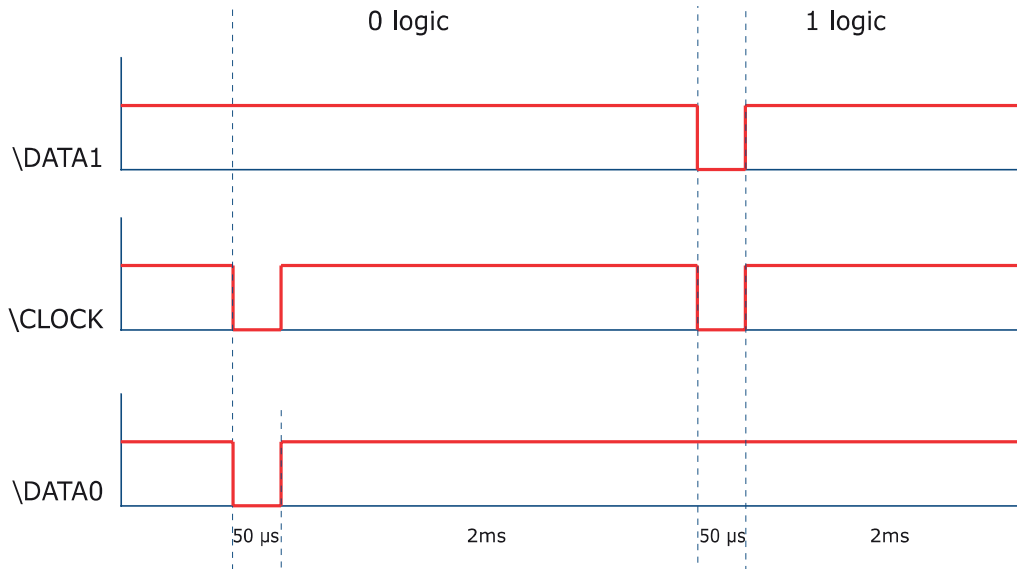

Open collector output with internal pulls up 1K at +5V or +12V according the ST4 position.

**26-bit Wiegand Output**

Format 26-bit hexadecimal. The output format is 26-bit Wiegand (Signals: DATA1, DATA0 and CLOCK)  
The frame is made of 26-bit and built as follow:

**1 - First parity:** 1-bit – even parity for the first 12-bit  
Code of the badge: 6 half byte represent the last 6 digit of the code (4bit = 1 digit of a code)  
Each byte is transferred from bit 7 to bit 0.

**2 - Second parity:** 1 bit – odd parity for the last 12-bit.

Bit 1	Bit 2 to bit 25	Bit 26
Even Parity on bit 2 to bit 13	Data (24 bit)	Odd Parity on bit 14 to bit 25

**Example:** code of the badge is 0100166A37.

<b>1</b>	<b>0001</b>	<b>0110</b>	<b>0110</b>	<b>1010</b>	<b>0011</b>	<b>0111</b>	<b>0</b>
Parity 1	1	6	6	A	3	7	Parity 2

The code transmitted is in hexadecimal format 166A37

Parity 1: 0 if the number of 1 in bit 2 to bit 13 is even,  
1 if the number of 1 in bit 2 to bit 13 is odd.

Parity 2: 0 if the number of 1 in bit 14 to bit 25 is odd,  
1 if the number of 1 in bit 14 to bit 25 is even.

# SOLARPW-STARPW

## Wiegand 125 Khz Proximity Readers

### 30-bit Wiegand Output

Signals output in open collectors with pull up in 30-bit hexadecimal format. The output format from the proximity reader is 30-bit wiegand (Signal: DATA1, DATA0 and CLOCK) and is structured as follow:

**1 - First parity:** 1 bit – even parity for the first 14-bit

Code: A code is formed from 7 half byte.

Each byte is transferred from bit 7 to bit 0.

**2 - Second parity:** odd parity for the last 14-bit.

Bit 1	Bit 2 to bit 29	Bit 30
Even Parity from bit 2 to bit 15	Data (28-bit)	Odd Parity from bit 16 to bit 29

**Example A:** Temic card decimal code: 689905 (in hexadecimal: A86F1).

1	0000	0000	1010	0110	0110	1111	0001	0
Parity 1	0	0	A	8	6	F	1	Parity 2

The code number of the card is 00A86F1 in hexadecimal.

**Example B:** EM badge hexadecimal code: 0100166A37.

1	0000	0000	0001	0001	0110	1011	0110	1
Parity 1	0	0	6	6	A	3	7	Parity 2

The code transmitted is in hexadecimal format 0166A37.

**Parity 1:** 0 if the number of 1 in bit 2 to bit 15 is even,

1 if the number of 1 in bit 2 to bit 15 is odd,

**Parity 2:** 0 if the number of 1 in bit 16 to bit 29 is odd,

1 if the number of 1 in bit 16 to bit 29 is even.

### 44-bit Wiegand Format Output

44-bit hexadecimal format. The output format from the proximity reader is 44-bit (Signal: DATA1, DATA0 and CLOCK) and is structured as follow:

**Data:** 10 digit code number hexadecimal MSByte first.

Each hexadecimal digit = 4 bit, MSBit first.

**LRC:** 4 bit = OR restricted in between the digit of the data, MSBit first.

Bit 1 to bit 40	Bit 41 to bit 44
Data MSBit first	LRC

**Example A:** EM badge hexadecimal code: 01001950C3.

0000	0000	0000	0000	0001	1001	0101	0000	1100	0011	0011
0	1	0	0	1	9	5	0	C	3	3

The code number of the card is: 01001950C3 in hexadecimal code.